



MICROBOARDS®
Technology



DVD Premium Series

Users Manual

www.microboards.com

Version 1.02

TABLE OF CONTENTS

System Overview	4
Unpacking your system.....	4
Microboards Statement Regarding Improper Duplication	4
Installation Requirements	5
Main Menu	6
Copy Disc to Disc.....	6
Simulation Disc to Disc	6
Erasing RW media	7
Setup Menu	8
Mode Select.....	9
DVD WR Speed.....	9
CD WR Speed	9
ISRC Check	9
Auto Run.....	9
Copy Quantity	9
Session Mode	9
Reader Select	9
Drive Inquiry.....	9
F/W Version	9
F/W Update.....	9
Log.....	9
Error Codes	10
Specifications.....	17
Supported Formats	17
Firmware Updates.....	17
Contact Information.....	17

System Overview

The DVD Premium Series employs up to 10 General Purpose DVD+R/DL recorders.

An intuitive, menu driven display and 5-button control interface provide one-touch operation for the novice user while providing advanced features for the professional.



Advanced Features:

- Stand-Alone DVD+R/RW/DL / CD-R duplicator
- One Touch duplication
- Auto Run option
- Speed selectable (1x to 16x for DVD+R and 4x to 48x for CD-R)
- Supports writing to DVD+R/RW/DL, CD-R/RW
- Copy and Verify
- Counter feature allows the user to input how many discs need to be copied and the keeps track of the total discs completed.
- Automatically detects DVD or CD masters
- Simulation mode to ensure recording stability
- Easy-to-read, two-line display for status and error reporting
- Updates easily installed through DVD/CD reader

Unpacking your system

When unpacking your duplicator, confirm the following items are included:

- DVD Premium Series duplicator
- Power cable
- Quick Start Guide
- Microboards Documentation CD

If any of these items are missing, please contact or Microboards Technology Technical Support at 952-556-1639.

IMPORTANT: Please keep all the packing for your DVD Premium Series duplicator. If your unit ever needs to be sent in for service, it must be returned in the original packing or the warranty will be voided.

Microboards Statement Regarding Improper Duplication

Microboards Technology fully supports the right of any business, organization, group, or individual to protect their property from unlicensed, unauthorized, or illegal duplication.

As a user of our equipment, we expect you to support that right as well.

Microboards Technology is neither responsible nor liable for the infringement of any laws regarding the illegal duplication of property. Microboards Technology products are in no way intended to encourage or condone such duplication.

Installation Requirements

System Setup

- Connect the power cable to the DVD Premium Series tower and plug in to a protected power outlet strip or UPS power supply.
- Turn on power to the tower. The system is now ready to use.

Install your DVD Premium Series duplicator in the following environment:

- On a level and stable surface
- In a well ventilated location
- Temperature and humidity
- Temperature: 5-40°
- Humidity: 20-80%RH (no dew formation)

Do not install it in the following places:

- Under direct sunlight (If the machine is exposed to sunlight, the light should be blocked by a curtain or blind.)
- A dusty location
- A place where there is a lot of vibration
- Near open flame
- A place where the temperature and humidity change drastically
- Near a heating device such as a heater or furnace
- A location where air from an air conditioner blows directly onto the unit
- Near a container filled with water such as a vase

In winter during times of low humidity or in a location where static electricity is generated, use an anti-static-electricity mat or humidifier to prevent static electricity.

Power supply

- Use house current as the power source for the unit.
- Do not use an outlet near a motor driven appliance (i.e. air conditioner, copying machine).
- Use an outlet with stable power supply voltages.
- Do not overload an outlet. Do not use a service outlet from a PCs or other office machine.
- Wire the power cord properly.
- Do not touch the power cord with a wet hand.
- Be careful not to damage the power cord.

Inspect the power cord periodically.
In the event that the power cord is damaged, replace the power cord.



Be sure to use a tool such as the screwdriver to change the 115/230V Switch.
Do not use your finger.

Main Menu

The Arrow buttons (▼▲) allow you to move forward or backward in the menu without selecting the current menu item. The NO button will move you to the next menu item. YES will select the current menu item.

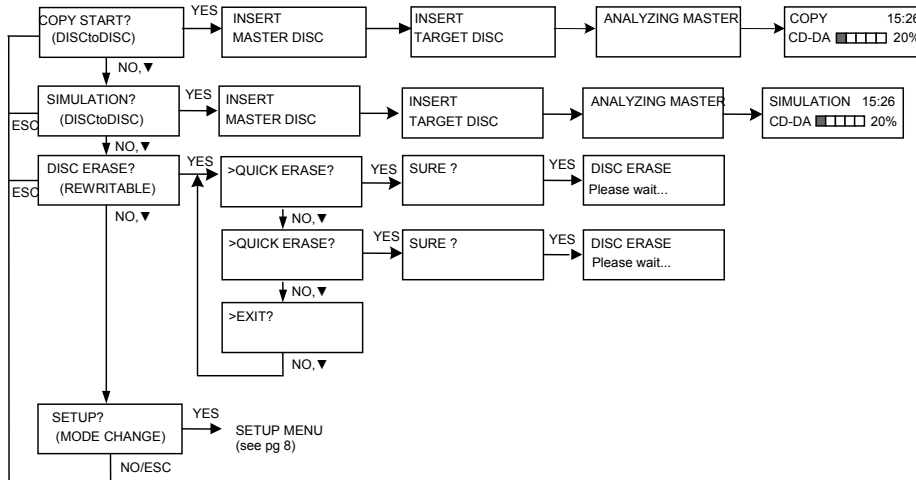

Copy Disc to Disc

- Place the Master Disc into the Reader drive.
Place the blank disc(s) into the Recorder drive(s) and wait 10 seconds for the light(s) on the front of the Recorder(s) to stop blinking. Note that the blanks must be of the same media type as the master; you cannot copy a CD master to DVD's, for instance.
- The display reads COPY START? (DISC to DISC).

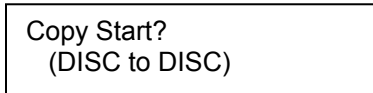

- Press YES. If you have the Auto Run feature set to ON, the duplication will begin when the master is loaded and all drives are loaded with blank media.
- The drive trays will open on any recorder without blank discs installed. If you do not want to make a copy in those drives, close the tray(s), wait for the drive light to go out, and then press the YES button to start the copy job.
- The display will now show the progress of the Copy Job.

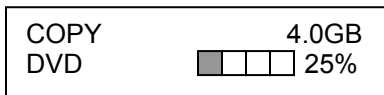

- The Recorder(s) will eject the recordable discs when the job is complete.

Simulation Disc to Disc

Important: Simulation is not allowed when using DVD+R/RW media.

- At the COPY START? (DISC to DISC) menu, press the NO or ▼ button until the display shows SIMULATION? (DISC to DISC).

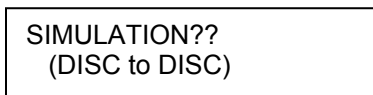

- Place the Master Disc into the Reader drive
- Place the blank disc(s) into the Recorder drive(s) and wait 10 seconds for the light(s) on the front of the Recorder(s) to stop blinking.
- Press YES.

5. The drive trays will open on any recorder without blank discs installed. If you do not want to make a copy in those drives, close the tray(s), wait for the drive light to go out, and then press the YES button to start the copy job.
6. The display will now show the progress of the Simulation Copy Job

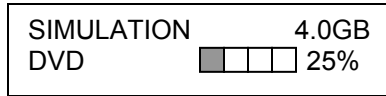

7. The Recorder(s) will eject the DVD-R discs when the job is complete.

Note: DVD-R media will NOT be recorded to in Simulation Mode.

Erasing RW media

1. At the COPY START? (DISC to DISC) menu, press the NO or ▼ button until the display shows DISC ERASE? (REWRITABLE):

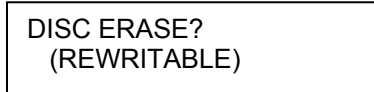

2. Load the Recorder(s) with the CD-RW or DVD-+RW media you wish to erase. You can erase one disc at a time or fill all the Recorders to erase multiple discs at once. All discs loaded must be of the same type.
3. Press the YES button
4. The next screen asks if you want to perform a Quick Erase.

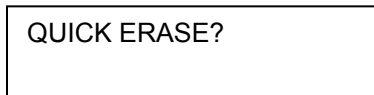

If you wish to perform a Full Erase, press the NO button.

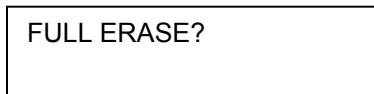

Pressing the YES button at either of these selections will show the following screen:

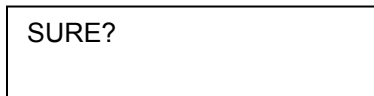

5. Press the YES button if you are sure you want to erase the DVD-+RW disc. If you do not wish to erase the disc, press the NO button and you will go back to the DISC ERASE screen (step 1).
6. The screen will now show:

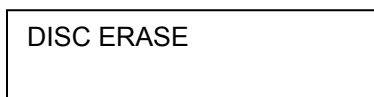

7. Once the erasing is complete, the Recorder(s) will eject the disc(s).

Setup Menu

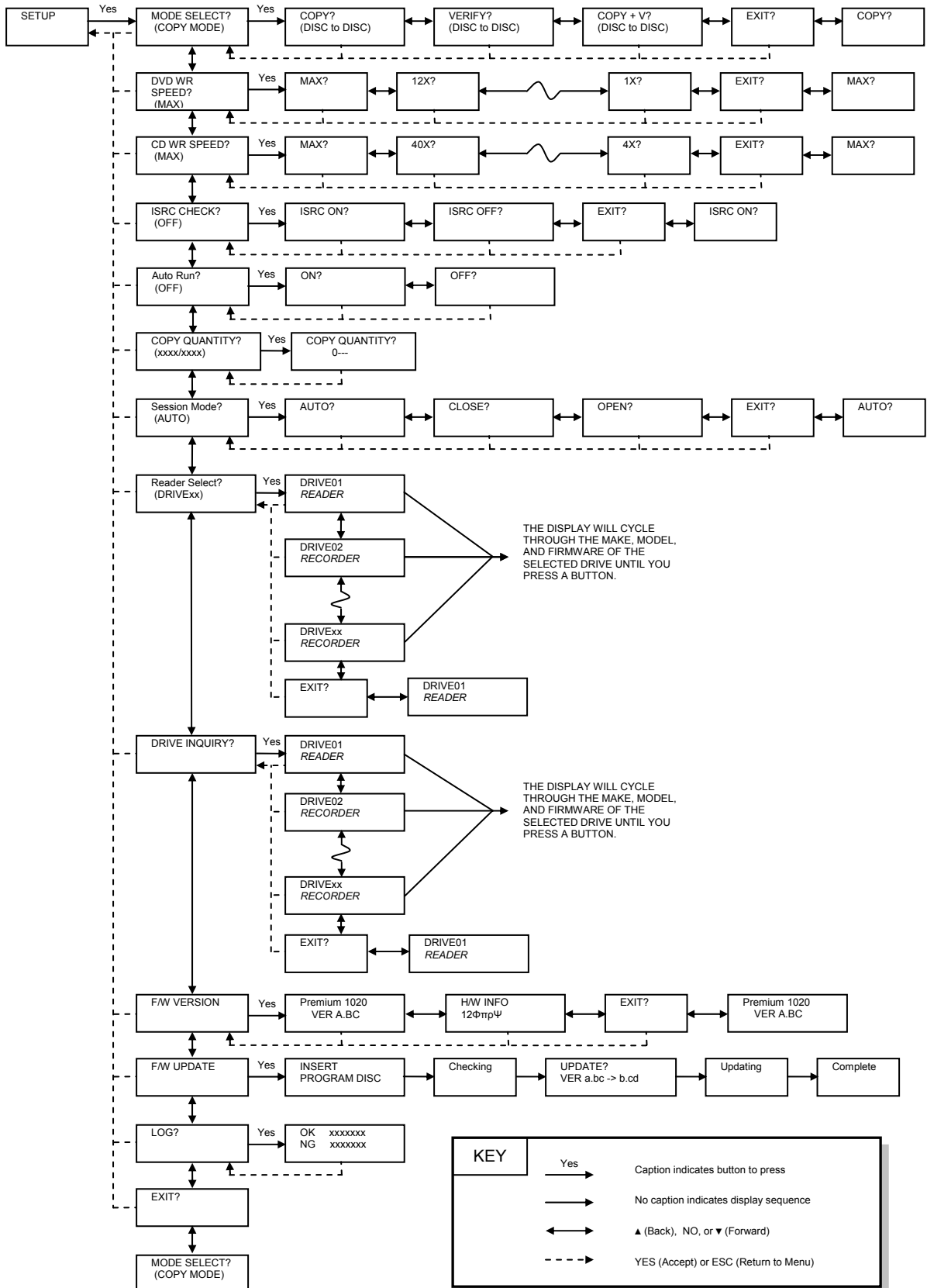

Error Codes**Read Errors**

ASC	ASCQ	Description
00	00	NO ADDITIONAL SENSE INFORMATION
00	06	I/O PROCESS TERMINATED, PLAY OPERATION ABORTED
00	11	AUDIO PLAY OPERATION IN PROGRESS
00	12	AUDIO PLAY OPERATION PAUSE
00	13	AUDIO PLAY OPERATION SUCCESSFULLY COMPLETED
00	14	AUDIO PLAY OPERATION STOPPED DUE TO ERROR
00	15	NO CURRENT AUDIO STATUS TO RETURN
00	17	CLEANINF REQUESTED
01	00	NO INDEX/SECTOR SIGNAL
02	00	NO SEEK COMPLETE
04	00	LOGICAL UNIT NOT READY, CAUSE NOT REPORTABLE
04	01	LOGICAL UNIT IS IN PROCESS OF BECOMING READY
04	02	LOGICAL UNIT NOT READY, INITIALIZING CMD. REQUESTED
04	03	LOGICAL UNIT NOT READY, MANUAL INTERVENTION REQUIRED
04	07	LOGICAL UNIT NOT READY, OPERATION IN PROGRESS
05	00	LOGICAL UNIT DOES NOT RESPOND TO SELECTION
06	00	NO REFERENCE POSITION FOUND (medium may be upside down)
08	00	LOGICAL UNIT COMMUNICATION FAILURE
08	01	LOGICAL UNIT COMMUNICATION TIME-OUT
08	02	LOGICAL UNIT COMMUNICATION PARITY ERROR
08	03	LOGICAL UNIT COMMUNICATION CRC ERROR (ULTRA-DMA/32)
09	00	TRACK FOLLOWING ERROR
09	01	TRACKING SERVO FAILURE
09	02	FOCUS SERVO FAILURE
09	03	SPINDLE SERVO FAILURE
0A	00	ERROR LOG OVERFLOW
0B	00	WARNING
0B	01	WARNING-SPECIFIED TEMPERATURE EXCEEDED
0B	02	WARNING-ENCLOSURE DEGRADED
10	00	ID CRC OR ECC ERROR
11	01	UNRECOVERED READ ERROR
11	02	ERROR TOO LONG TO CORRECT
11	05	L-EC UNCORRECTABLE ERROR
11	06	CIRC UNRECOVERED ERROR
11	0F	ERROR READING UPC/EAN NUMBER
11	10	ERROR – LOSS PF STREAMING
12	00	ADDRESS MARK NOT FOUND FOR ID FIELD
13	00	ADDRESS MARK NOT FOUND FOR DATA FIELD
14	01	RECORD NOT FOUND
14	05	RECORD NOT FOUND – RECOMMEND REASSIGNMENT
14	06	RECORD NOT FOUND – DATA AUTO – REALLOCATED
15	00	RANDOM POSITIONING ERROR
15	01	MECHANICAL POSITIONING ERROR
15	02	POSITIONING ERROR DETECTED BY READ OF MEDIUM
17	00	RECOVERED DATA WITH NO EOR CORRECTION APPLIED
17	01	RECOVERED DATA WITH RETRIES
17	02	RECOVERED DATA WITH POSITIVE HEAD OFFSET

17	03	RECOVERED DATA WITH NEGATIVE HEAD OFFSET
17	04	RECOVERED DATA WITH RETRIES AND/OR CIRC APPLIED
17	05	RECOVERED DATA USING PREVIOUS SECTOR ID
18	00	RECOVERED DATA WITH ERROR CORRECTION APPLIED
18	01	RECOVERED DATA WITH ERROR CORP. & RETRIES APPLIED
18	03	RECOVERED DATA WITH CIRC
18	04	RECOVERED DATA WITH L-EC
1A	00	PARAMETER LIST LENGTH ERROR
1B	00	SYNCHRONOUS DATA TRANSFER ERROR
1E	00	RECOVERED ID WITH ECC CORRECTION
20	00	INVALID COMMAND OPERATION CODE
21	00	LOGICAL BLOCK ADDRESS OUT OF RANGE
24	00	INVALID FIELD IN CDB
25	00	LOGICAL UNIT NOT SUPPORTED
26	00	INVALID FIELD IN PARAMETER LIST
26	01	PARAMETER NOT SUPPORTED
26	02	PARAMETER VALUE INVALID
26	03	THRESHOLD PARAMETERS NOT SUPPORTED
26	04	INVALID RELEASE OF ACTIVE PERSISTENT RESERVATION
28	00	NOT READY TO READY CHANGE, MEDIUM MAY HAVE CHANGED
29	00	POWER ON, RESET, OR BUS DEVICE RESET OCCURRED
29	01	POWER ON OCCURRED
29	02	SCSI BUS RESET OCCURRED
29	03	BUS DEVICE RESET FUNCTION OCCURRED
29	04	DEVICE INTERNAL RESET
2A	00	PARAMETERS CHANGED
2A	01	MODE PARAMETERS CHANGED
2A	02	LOG PARAMETERS CHANGED
2A	03	RESERVATIONS PREEMPTED
2B	00	COPY CANNOT EXECUTE SINCE HOST CANNOT DISCONNECT
2C	00	COMMAND SEQUENCE ERROR
2C	05	PERSISTENT PREVENT CONFLICT
2F	00	COMMANDS CLEARED BY ANOTHER INITIATOR
30	00	INCOMPATIBLE MEDIUM INSTALLED
30	01	CANNOT READ MEDIUM - UNKNOWN FORMAT
30	02	CANNOT READ MEDIUM - INCOMPATIBLE FORMAT
30	03	CLEANSING CARTRIDGE INSTALLED
35	00	ENCLOSURE SERVICES FAILURE
35	01	UNSUPPORTED ENCLOSURE FUNCTION
35	02	ENCLOSURE SERVICES UNAVAILABLE
35	03	ENCLOSURE SERVICES TRANSFER FAILURE
35	04	ENCLOSURE SERVICES TRANSFER REFUSED
39	00	SAVING PARAMETERS NOT SUPPORTED
3A	00	MEDIUM NOT PRESENT
3A	01	MEDIUM NOT PRESENT-TRAY CLOSED
3A	02	MEDIUM NOT PRESENT-TRAY OPEN
3B	0F	END OF MEDIUM REACHED
3B	11	MEDIUM MAGAZINE NOT ACCESSIBLE
3B	12	MEDIUM MAGAZINE REMOVED
3B	13	MEDIUM MAGAZINE INSERTED
3B	14	MEDIUM MAGAZINE LOCKED

3B	15	MEDIUM MAGAZINE UNLOCKED
3B	16	MECHANICAL POSITIONING OR CHANGER ERROR
3D	00	INVALID BITS IN IDENTIFY MESSAGE
3E	00	LOGICAL UNIT HAS NOT SELF-CONFIGURED YET
3E	01	LOGICAL UNIT FAILURE
3E	02	TIMEOUT ON LOGICAL UNIT
3F	00	TARGET OPERATING CONDITIONS HAVE CHANGED
3F	01	MICROCODE HAS BEEN CHANGED
3F	02	CHANGED OPERATING DEFINITION
3F	03	INQUIRY DATA HAS CHANGED
40	NN	DIAGNOSTIC FAILURE ON COMPONENT NN (80H-FFH)
43	00	MESSAGE ERROR
44	00	INTERNAL TARGET FAILURE
45	00	SELECT OR RESELECT FAILURE
46	00	UNSUCCESSFUL SOFT RESET
47	00	SCSI PARITY ERROR
48	00	INITIATOR DETECTED ERROR MESSAGE RECEIVED
49	00	INVALID MESSAGE ERROR
4A	00	COMMAND PHASE ERROR
4B	00	DATA PHASE ERROR
4C	00	LOGICAL UNIT FAILED SELF-CONFIGURATION
4D	NN	TAGGED OVERLAPPED COMMANDS (NN=QUEUE TAG)
4E	00	OVAERLAPPED COMMANDS ATTEMPTED
53	00	MEDIA LOAD OR EJECTED FAILED
53	02	MEDIUM REMOVAL PREVENTED
55	00	SYSTEM RESOURCE FAILURE
57	00	UNABLE TO RECOVER TABLE-OF-CONTENTS
5A	00	OPERATOR REQUEST OR STATE CHANGE INPUT
5A	01	OPERATOR MEDIUM REMOVAL REQUEST
5B	00	LOG EXCEPTION
5B	01	THRESHOLD CONDITION MET
5B	02	LOG COUNTER AT MAXIMUM
5B	03	LOG LIST CODES EXHAUSTED
5D	00	FAILURE PREDICTION THRESHOLD EXCEEDED - Predicted Logical Unit Failure
5D	01	FAILURE PREDICTION THRESHOLD EXCEEDED - Predicted Media Failure
5D	FF	FAILURE PREDICTION THRESHOLD EXCEEDED (FALSE)
5E	00	LOW POWER CONDITION ON
5E	01	IDLE CONDITION ACTIVATED BY TIMER
5E	02	STANDBY CONDITION ACTIVATED BY COMMAND
5E	03	IDLE CONDITION ACTIVATED BY COMMAND
5E	04	STANDBY CONDITION ACTIVATED BY COMMAND
63	00	END OF USER AREA ENCOUNTERED ON THIS TRACK
63	01	PACKET DOES NOT FIT IN AVAILABLE SPACE
64	00	ILLEGAL MODE FOR THIS TRACK
65	00	VOLTAGE FAULT
73	00	CD CONTROL ERROR
80	xx	VENDOR SPECIFIC

Write Errors

ASC	ASCQ	Description
00	00	NO ADDITIONAL SENSE INFORMATION
00	06	I/O PROCESS TERMINATED, PLAY OPERATION ABORTED
00	11	AUDIO PLAY OPERATION IN PROGRESS
00	12	AUDIO PLAY OPERATION PAUSED
00	13	AUDIO PLAY OPERATION SUCCESSFULLY
00	14	AUDIO PLAY OPERATION STOPPED DUE TO ERRPOR
00	15	NO CURRENT AUDIO STATUS TO RETURN
02	00	NO SEEK COMPLETE
04	00	LOGICAL UNIT NOT READY, CAUSE NOT REPORTABLE
04	01	LOGICAL UNIT IS IN PROCESS OF BECOMING READY
04	02	LOGICAL UNIT NOT READY, INITIALIZING CMD. REQUIRED
04	03	LOGICAL UNIT NOT READY, MANUAL INTERVENTION REQUIRED
04	04	LOGICAL UNIT NOT READY, FORMAT IN PROGRESS
04	07	LOGICAL UNIT NOT READY, OPERATION IN PROGRESS
04	08	LOGICAL UNIT NOT READY, LONG WRITE IN PROGRESS
05	00	LOGICAL UNIT DOES NOT RESPOND TO SELECTION
06	00	NO REFERENCE POSITION FOUND
08	00	LOGICAL UNIT COMMUNICATION FAILURE
08	01	LOGICAL UNIT COMUUNICATION TIME-OUT
08	02	LOGICAL UNIT COMMUNICATION PARITY ERROR
08	03	LOGICAL UNIT COMMUNICATION CRC ERROR (ULTRA-DMA/32)
09	00	TRACK FOLLOWING ERROR
09	01	TRACKING SERVO FAILURE
09	02	FOCUS SERVO FAILURE
09	03	SPINDLE SERVO FAILURE
0A	00	ERROR LOG OVERFLOW
0B	00	WARNING
0B	01	WARNING-SPECIFIED TEMPERATURE EXCEEDED
0B	02	WARNING-ENCLOSURE DEGRADED
0C	00	WRITE ERROR
0C	02	WRITE ERROR-RECOVERED WITH AUTO REALLOCATION
0C	03	WRITE ERROR-RECOMMEND REASSIGNMENT
0C	07	WRITE ERROR-RECOVERY NEEDED
0C	08	WRITE ERROR-RECOVERY FAILED
0C	09	WRITE ERROR-LOSS OF STREAMING
0C	0A	WRITE ERROR-PADDING BLOCKS ADDED
11	00	UNRECOVERED READ ERROR
11	06	CIRC UNRECOVERED ERROR
15	00	RANDOM POSITIONING ERROR
15	01	MECHANICAL POSITIONING ERROR
15	02	POSITIONING ERROR DETECTED BY READ OF MEDIUM
16	00	DATA SYNCHRONIZATION MARK ERROR
16	01	DATA SYNC ERROR-DATA REWRITTEN
16	02	DATA SYNC ERROR-RECOMMEND REWRITE
16	03	DATA SYNC ERROR-DATA ATUO-REALLOCATED
16	04	DATA SYNC ERROR-RECOMMEND REASSIGNMENT
17	00	RECOVERED DATA WITH NO ERROR CORRECTION APPLIED
17	01	RECOVERED DATA WITH RETRIES
17	02	RECOVERED DATA WITH POSITIVE HEAD OFFSET

17	03	RECOVERED DATA WITH NEGATIVE HEAD OFFSET
17	04	RECOVERED DATA WITH RETRIES AND/OR CIRC APPLIED
17	05	RECOVERED DATA USING PREVIOUS SECTOR ID
17	06	RECOVERED DATA WITHOUT ECC - DATA AUTO-REALLOCATED
17	07	RECOVERED DATA WITHOUT ECC - RECOMMEND REASSIGNMENT
17	08	RECOVERED DATA WITHOUT ECC - RECOMMEND REWRITE
17	09	RECOVERED DATA WITHOUT ECC - DATA REWRITTEN
18	00	RECOVERED DATA WITH ERROR CORRECTION APPLIED
18	01	RECOVERED DATA WITH ERROR CORR. & RETRIES APPLIED
18	02	RECOVERED DATA - DATA AUTO-REALLOCATED
18	03	RECOVERED DATA WITH CIRC
18	04	RECOVERED DATA WITH L-EC
18	05	RECOVERED DATA - RECOMMEND REASSIGNMENT
18	06	RECOVERED DATA - RECOMMEND REWRITE
18	07	RECOVERED DATA WITH ECC - DATA REWRITTEN
19	00	DEFECT LIST NOT ERROR
19	01	DEFECT LIST NOT AVAILABLE
19	02	DEFECT LIST ERROR IN PRIMARY LIST
19	03	DEFECT LIST ERROR IN GROWN LIST
1A	00	PARAMETER LIST LENGTH ERROR
1B	00	SYNCHRONOUS DATA TRANSFER ERROR
1C	00	DEFECT LIST NOT FOUND
1C	01	PRIMARY DEFECT LIST NOT FOUND
1C	02	GROWN DEFECT LIST NOT FOUND
1D	00	MISCOMPARE DURING VERIFY OPERATION
20	00	INVALID COMMAND OPERATION CODE
21	00	LOGICAL BLOCK ADDRESS OUT OF RANGE
21	02	INVALID ADDRESS FOR WRITE
24	00	INVALID FIELD IN CDB
25	00	LOGICAL UNIT NOT SUPPORTED
26	00	INVALID FIELD IN PARAMETER LIST
26	01	PARAMETER NOT SUPPORTED
26	02	PARAMETER VALUE INVALID
26	03	THRESHOLD PARAMETERS NOT SUPPORTED
26	04	INVALID RELEASE OF ACTIVE PERSISTENT RESERVATION
27	00	WRITE PROTECTED
27	01	HARDWARE WRITE PROTECTED
27	02	LOGICAL UNIT SOFTWARE WRITE PROTECTED
27	03	ASSOCIATED WRITE PROTECT
27	04	PERSISTENT WRITE PROTECT
27	05	PERSISTENT WRITE PROTECT
27	06	CONDITIONAL WRITE PROTECT
28	00	NOT READY TO READY CHANGE, MEDIUM MAY HAVE CHANGED
29	00	POWER ON, RESET, OR BUS DEVICE RESET OCCURRED
29	01	POWER ON OCCURRED
29	02	SCSI BUS RESET OCCURRED
29	03	BUS DEVICE RESET FUNCTION OCCURRED
29	04	DEVICE INTERNAL RESET
2A	00	PARAMETERS CHANGED
2A	01	MODE PARAMETERS CHANGED

2A	02	LOG PARAMETERS CHANGED
2A	03	RESERVATIONS PREEMPTED
2B	00	COPY CANNOT EXECUTE SINCE HOST CANNOT DISCONNECT
2C	00	COMMAND SEQUENCE ERROR
28	00	NOT READY TO READY CHANGE, MEDIUM MAY HAVE CHANGED
29	00	POWER ON, RESET, OR BUS DEVICE RESET OCCURRED
2A	00	PARAMETERS CHANGED
2A	01	MODE PARAMETERS CHANGED
2C	00	COMMAND SEQUENCE ERROR
2C	03	CURRENT PROGRAM AREA IS NOT EMPTY
2C	04	CURRENT PROGRAM AREA IS EMPTY
2C	05	PERSISTENT PREVENT CONFLICT
2E	00	INSUFFICIENT TIME FOR OPERATION
2F	00	COMMANDS CLEARED BY ANOTHER INITIATOR
30	00	INCOMPATIBLE MEDIUM INSTALLED
30	01	CANNOT READ MEDIUM - UNKNOWN FORMAT
30	02	CANNOT READ MEDIUM - INCOMPATIBLE FORMAT
30	05	CANNOT WRITE MEDIUM - INCOMPATIBLE FORMAT
30	06	CANNOT FORMAT MEDIUM - INCOMPATIBLE MEDIUM
30	08	CANNOT WRITE - APPLICATION CODE MISMATCH
30	09	CURRENT SESSION NOT FIXATED FOR APPEND
31	00	MEDIUM FORMAT CORRUPTED
31	01	FORMAT COMMAND FAILED
32	00	NO DEFECT SPARE LOCATION AVAILABLE
32	01	DEFECT LIST UPDATE FAILURE
35	00	ENCLOSURE SERVICES FAILURE
35	01	UNSUPPORTED ENCLOSURE FUNCTION
35	02	ENCLOSURE SERVICES UNAVAILABLE
35	03	ENCLOSURE SERVICES TRANSFER FAILURE
35	04	ENCLOSURE SERVICES TRANSFER REFUSED
37	00	ROUNDED PARAMETER
39	00	SAVING PARAMETERS NOT SUPPORTED
3A	00	MEDIUM NOT PRESENT
3A	01	MEDIUM NOT PRESENT - TRAY CLOSED
3A	02	MEDIUM NOT PRESENT - TRAY OPEN
3D	00	INVALID BITS IN IDENTIFY MESSAGE
3E	00	LOGICAL UNIT HAS NOT SELF-CONFIGURED YET
3E	01	LOGICAL UNIT FAILURE
3E	02	TIMEOUT ON LOGICAL UNIT
3F	00	TARGET OPERATING CONDITIONS HAVE CHANGED
3F	01	MICROCODE HAS BEEN CHANGED
3F	02	CHANGED OPERATING DEFINITION
3F	03	INQUIRY DATA HAS CHANGED
40	NN	DIAGNOSTIC FAILURE ON COMPONENT NN (80H-FFH)
43	00	MESSAGE ERROR
44	00	INTERNAL TARGET FAILURE
45	00	SELECT OR RESELECT FAILURE
46	00	UNSUCCESSFUL SOFT RESET
47	00	SCSI PARITY ERROR
48	00	INITIATOR DETECTED ERROR MESSAGE RECEIVED
49	00	INVALID MESSAGE ERROR

4A	00	COMMAND PHASE ERROR
4B	00	DATA PHASE ERROR
4C	00	LOGICAL UNIT FAILED SELF-CONFIGURATION
4D	NN	TAGGED OVERLAPPED COMMANDS (NN=QUEUE TAG)
4E	00	OVAERLAPPED COMMANDS ATTEMPTED
51	00	ERASE FAILURE
51	01	ERASE FAILURE - Incomplete erase operation detected
53	00	MEDIA LOAD OR EJECT FAILED
53	02	MEDIUM REMOVAL PREVENTED
55	00	SYSTEM RESOURCE FAILURE
57	00	UNABLE TO RECOVER TABLE-OF-CONTENTS
5A	00	OPERATOR REQUEST OR STATE CHANGE INPUT
5A	01	OPERATOR MEDIUM REMOVAL REQUEST
5A	02	OPERATOR SELECTED WRITE PROTECT
5A	03	OPERATOR SELECTED WRITE PERMIT
5B	00	LOG EXCEPTION
5B	01	THRESHOLD CONDITION MET
5B	02	LOG COUNTER AT MAXIMUM
5B	03	LOG LIST CODES EXHAUSTED
5D	00	FAILURE PREDICTION THRESHOLD EXCEEDED -
5D	01	FAILURE PREDICTION THRESHOLD EXCEEDED - Predicted Media Failure
5D	03	FAILURE PREDICTION THRESHOLD EXCEEDED - Predicted Spare Area Exhaustion
5D	FF	FAILURE PREDICTION THRESHOLD EXCEEDED (FALSE)
5E	00	LOW POWER CONDITION ON
5E	01	IDLE CONDITION ACTIVATED BY TIMER
5E	02	STANDBY CONDITION ACTIVATED BY COMMAND
5E	03	IDLE CONDITION ACTIVATED BY COMMAND
5E	04	STANDBY CONDITION ACTIVATED BY COMMAND
63	00	END OF USER AREA ENCOUNTERED ON THIS TRACK
64	00	ILLEGAL MODE FOR THIS TRACK
64	01	INVALID PACKET SIZE
65	00	VOLTAGE FAULT
72	00	SESSION FIXATION ERROR
72	01	SESSION FIXATION ERROR WRITING LEAD-IN
72	02	SESSION FIXATION ERROR WRITING LEAD-OUT
72	03	SESSION FIXATION ERROR - INCOMPATIBLE TRACK IN SESSION
72	04	EMPTY OR PARTIALLY WRITTEN RESERVED TRACK
72	05	NO MORE RZONE RESERVATIONS ARE ALLOWED
73	00	CD CONTROL ERROR
73	01	POWER CALIBRATION AREA ALMOST FULL
73	02	POWER CALIBRATION AREA IS FULL
73	03	POWER CALIBRATION AREA ERROR
73	04	PROGRAM MEMORY AREA UPDATE FAILURE
73	05	PROGRAM MEMORY AREA/RMA IS FULL
73	06	PROGRAM MEMORY AREA/RMA IS (almost) FULL
B6	00	MEDIA LOAD/EJECT MECHANISM FAILED
B9	00	PLAY OPERATION ABORTED
80	FF	VENDOR SPECIFIC

Specifications

DVD Recorder Drive:	DVD+R/RW/DL CD-R/RW Recorder
Power Source:	115V/230V 50-60Hz switchable power supply
Weight:	58 pounds
Dimensions:	7.48" (W) x 16.75" (D) x 24.5" (H)
Power supply:	400W
Environment:	Temperature: 40°C (104°F) / 5°C (41°F) Humidity: 20% - 80%

Supported Formats

Recording format	CD	CD-ROM Mode 1, CD-ROM XA Mode 2 (form 1, form 2), Photo CD, CD-DA (Audio CD), CD-Extra, CD-R, CD-RW
	DVD	DVD-ROM, DVD+R/RW/DL, DVD-VIDEO
Recording capacity (nominal)	CD	700MB
	DVD	4.7GB for General DVD 8.3GB for Dual Layer
Applicable media	CD	CD-R, CD-RW
	DVD	DVD+R, DVD+RW, DVD+R DL

Firmware Updates

Occasionally it may be necessary to load updated firmware on to the DVD Premium Series duplicator. Only those firmware versions recommended and provided by Microboards Technical Support for this specific product should be installed. Installation of an incorrect firmware on any Microboards Technology product may result in any remaining warranty being voided.

Contact Information

For technical questions or support issues, please contact Microboards Technology technical support at PH: 952-556-1639, FAX: 952-556-1628, by email at support@microboards.com or on the web at <http://www.microboards.net>.